

SONY
make.believe

4K SXRD Home Cinema Projector

VPL-VW1000ES
4K Home Cinema Projector

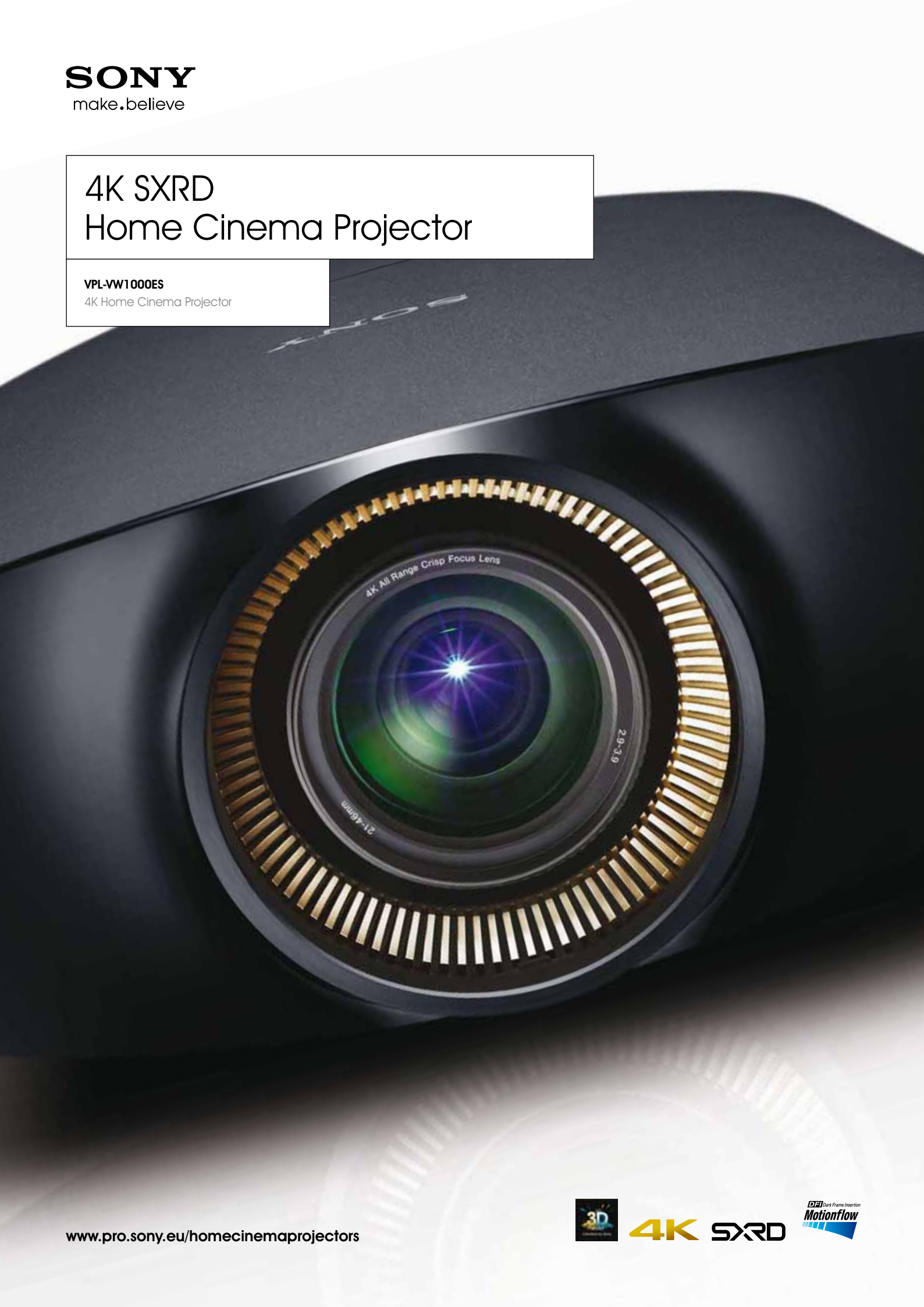

www.pro.sony.eu/homecinemaprojectors



4K SXRD





4K Images Provide Fully Immersive Visual Experience

The VPL-VW1000ES projector is packed with advanced technologies to make watching 2D and 3D content at home just like being at the movies, from the 4K lens and rich colour reproduction to super high 2000 lumen brightness and a dynamic contrast ratio of 1,000,000:1. 4K revolutionises the home cinema experience, delivering over 4x the quality of Full HD.

4K

Features

4K native resolution for no compromise with more than four times Full HD images

The VPL-VW1000ES 4K home cinema projector offers DCI* based 4096 x 2160 resolution, more than 4x the resolution of Full HD. The projector's 4K SXR panels have been specially developed by Sony for the VPL-VW1000ES, utilising 4K expertise from the professional cinema market. They deliver a native 4K picture, with no electronic enhancement of pixels.

*DCI: The standard of digital cinema distribution

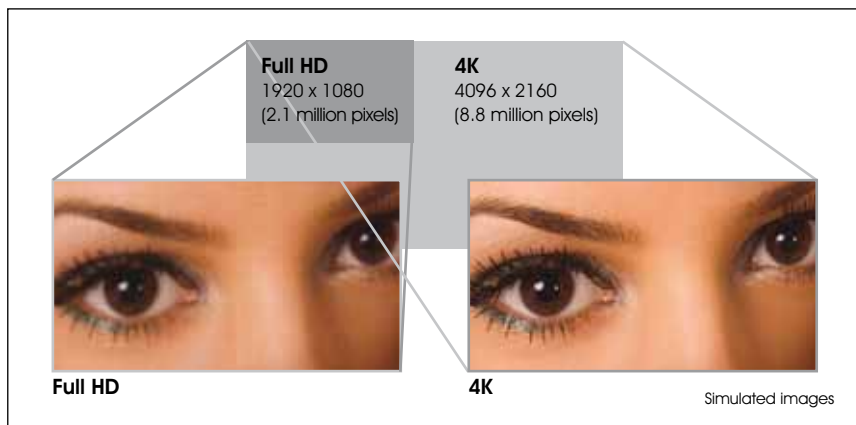

Remarkable dynamic contrast for the highest picture quality

The projector's 4K native SXR panels produce outstanding native device contrast, which reproduce deep blacks by improved flatness level of the pixel surface. When combined with Sony's Advanced Iris3 technology, the projector can achieve an incredible 1,000,000:1 dynamic contrast for the best ever images.

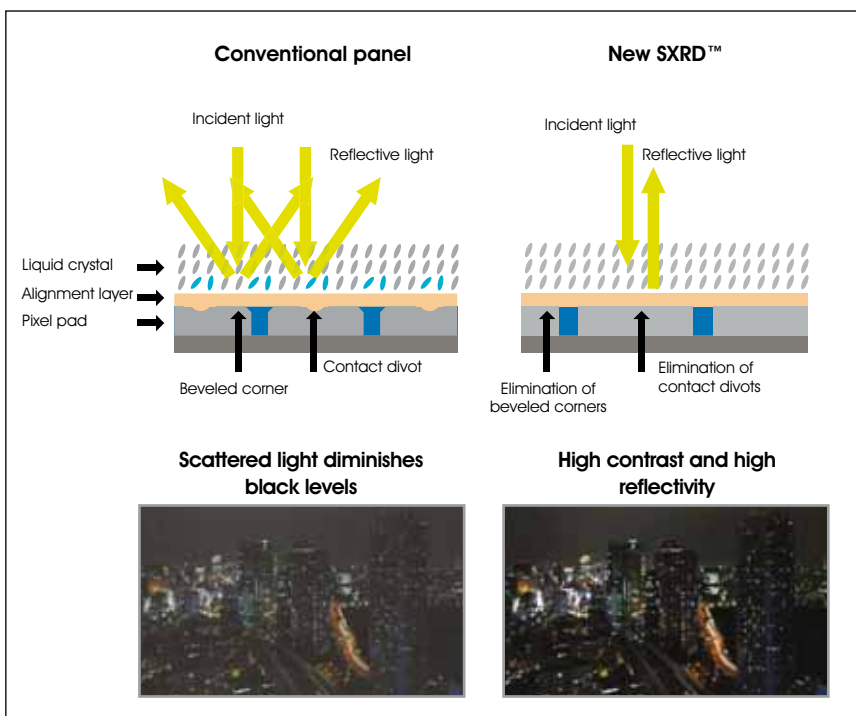

Simulated images



Features

High brightness of 2,000lm for optimum images in the home

With 2,000 ANSI-lumen brightness, the VPL-VW1000ES delivers nearly twice the output of previous Sony home cinema projectors. Combined with 4K SXRD panels, the projector is able to offer both higher brightness and higher contrast ratio for optimum viewing in the home environment.

"Reality Creation" 4K up-scaling to watch Blu-ray Disc™ content in 4K

In addition to supporting 4K native resolution, the VPL-VW1000ES projector also features an exclusive Super Resolution 4K upscaler "RealityCreation" that dramatically enhances high definition 1080p content, allowing viewers to get the most from their existing Blu-ray Disc™ libraries at home. For greater versatility, it can also display Full HD 3D and 4K up-scaling of 3D movies.

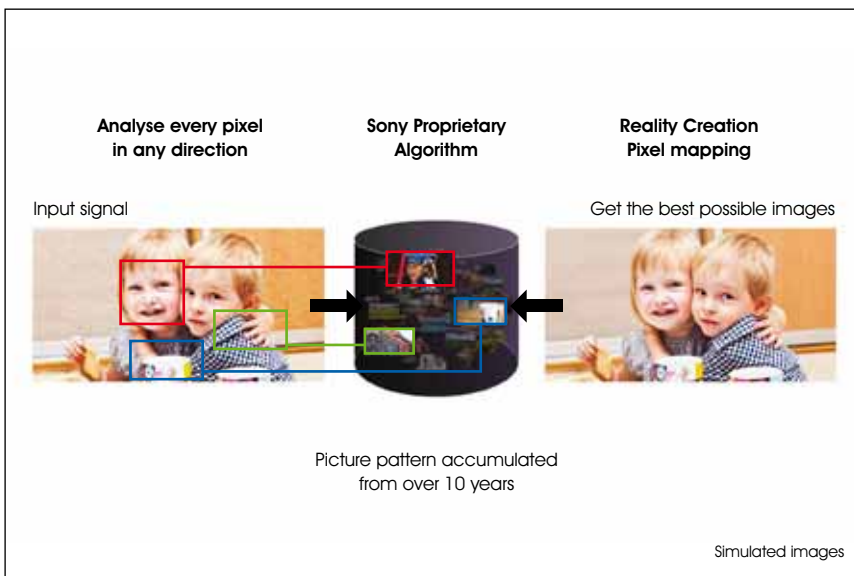
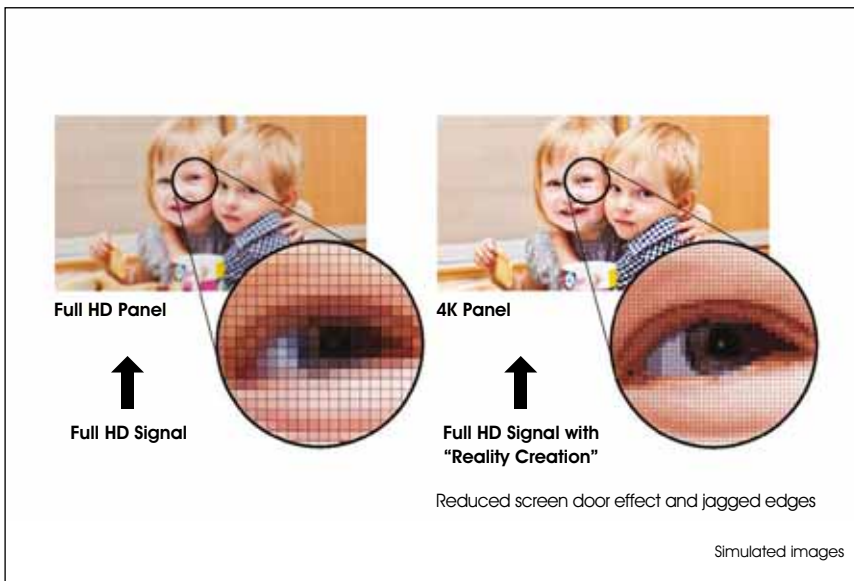

Features

Wide colour space (DCI, Adobe RGB) for richer picture quality

The VPL-VW1000ES offers a wider than normal colour space, enabling it to show the fuller colour information provided by the professional DCI colour specification and the Adobe RGB colour space.

For cinema
BT.709 (sRGB) → DCI

For photos
BT.709 (sRGB) → Adobe RGB Simulated Images

DCI: The standard of Digital Cinema distribution.

Lens optimised for 4K images

Sony has developed the 4K All-Range Crisp Focus (ARC-F) lens specifically for the VPL-VW1000ES projector to produce optimised 4K images. By incorporating this super high-resolution lens, high precision and detail are seen in all corners of the image.

Unoptimised Lens → All Range Crisp Focus (ARC-F) Lens for 4K

Simulated Images

Panel alignment expertise

The three 4K native panels in the projector utilise Sony's panel alignment expertise to produce precise convergence of the three RGB colour pictures, ensuring the three colour images are perfectly set up.

Low precision model → VPL-VW1000ES with precision alignment

Simulated Images



Features

Experience blur-free action with Motionflow

To bring the thrill of watching fast-paced, cinematic action to the home, the VPL-VW1000ES features a technology called Motionflow, which makes motion much smoother. This innovative process creates and inserts artificial frames, first comparing key visual factors on successive frames – then calculating the split second of ‘missing’ action in the sequence. This action mimics that of actual movie projection, viewers will experience movies and sports with a greater sense of realism than ever before.

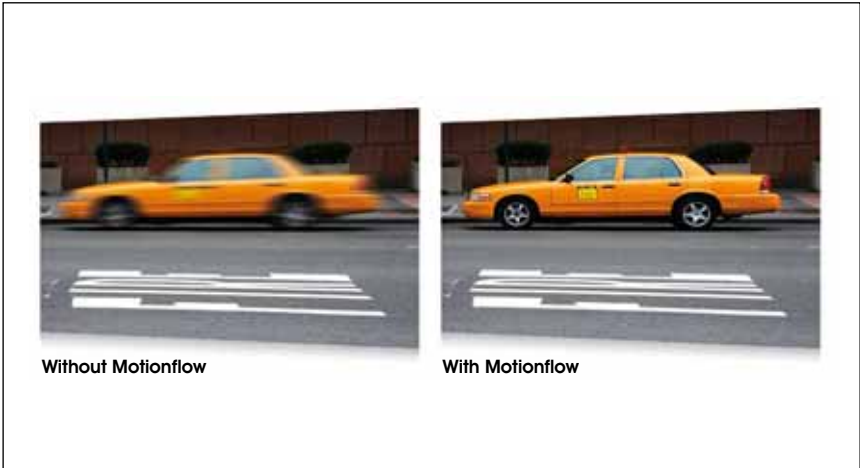

Zoom lens and wider lens shift for maximum installation flexibility

The VPL-VW1000ES combines a 2.1 zoom powered lens to provide the maximum flexibility for home installations, including high ceiling mounting. A wide lens shift range of 80% vertical and 31% horizontal reduces the need for additional platform extensions in ceiling mounts.

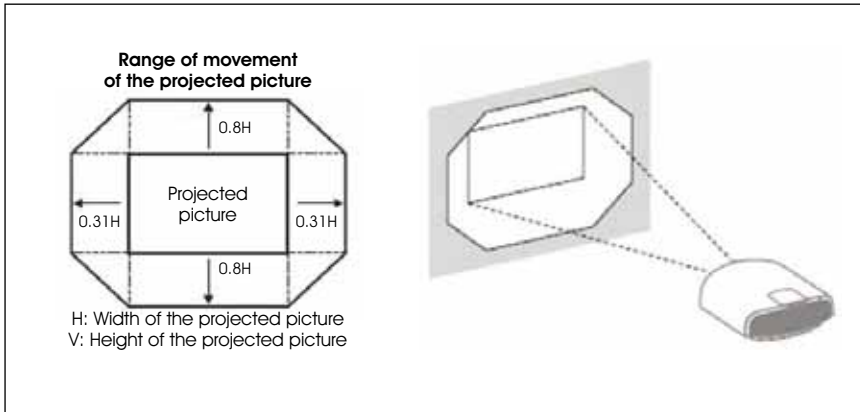

Picture position memory to meet a movie's aspect ratio

The VPL-VW1000ES has picture position memory, which memorises the position of the zoom lens. Users can match a movie's aspect ratio, including 16:9 and Cinema scope, and store the settings in the projector for easy recall.

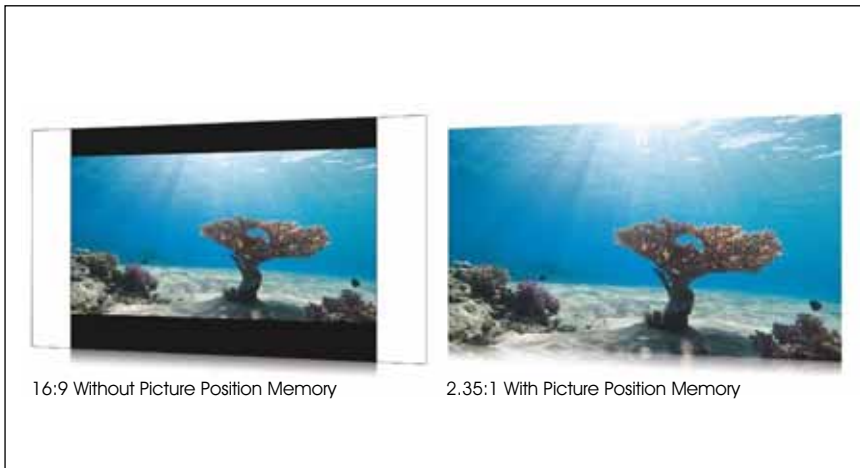

Home automation interfaces and accreditations

The VPL-VW1000ES comes with an RS232 interface, RJ45 control, dual triggers, IR-IN and self-diagnosis (for checking lamp life, etc.). The projector is also compatible with many home automation integrators and has AMX, Control 4 and Crestron certification.



Improved emission power for built-in 3D transmitter

The projector has a built-in 3D transmitter to synchronise 3D glasses, which alleviates the need for a cable. The emission power of the transmitter has also been boosted by 30% compared to previous models, allowing much wider coverage of the 3D signal.

Noise reduction technology

The VPL-VW1000ES incorporates the latest noise reduction technology to minimise projector noise as much as possible.

Simultaneous anamorphic and 3D viewing

The VPL-VW1000ES is able to display anamorphic images and 3D without changing the lens, making it as user-friendly as possible.

Dimensions

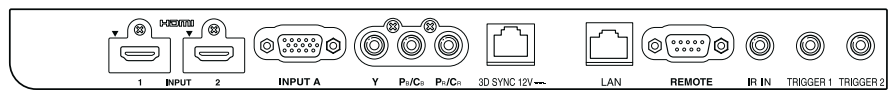
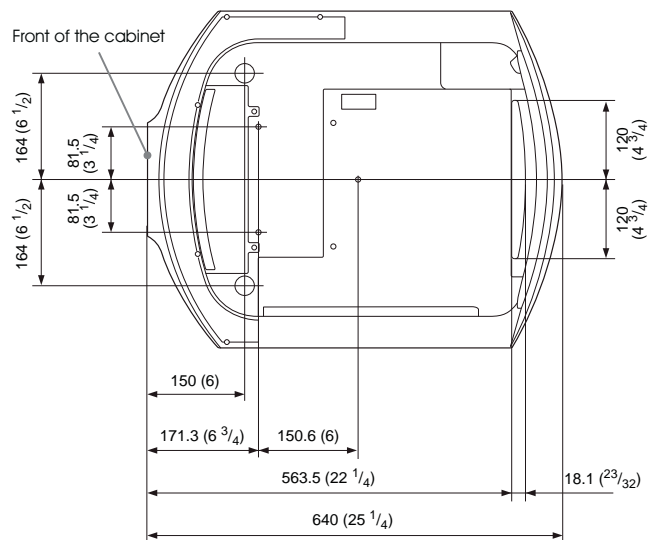
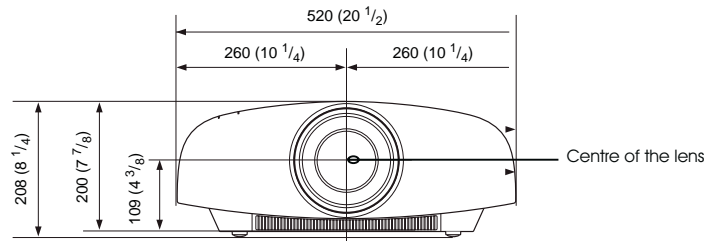

PrimeSupport

- Cover for three years – from the product purchase date.
- Specialist telephone support – an exclusive multi-lingual telephone helpline staffed by technical experts with detailed understanding of projector products.
- Collect-and-deliver repair service – if your problem cannot be resolved via the helpline, we'll activate our no-hassle collect-and-deliver repair service. All financial costs are covered – parts, labour and logistics to and from our state-of-the-art European repair centres.
- PrimeSupport will be provided through the Sony accredited partner.

With VPL home projectors, PrimeSupport also includes:

Free loan unit – you'll receive a free loan unit of similar specification if repairs are likely to exceed 10 working days, minimising your disruption.

Sony. The clear choice for home cinema.



Technical Specifications

Specifications		VPL-VW1000ES
Optical		
Light Output		2000 lumens
LCD Panels		0.74"x3 SXR Panel
Panel Display Resolution		4096x2160 dots
Contrast Ratio ^{*1}		1,000,000:1 (Dynamic Contrast)
Light Source		Ultra High Pressure Lamp 330 W type
Recommended Lamp Replacement Time ^{*2}		2000H (Lamp mode: High) 2500H (Lamp mode: Low)
Projection Lens	Zoom / Focus	Approx. 2.1x Powered Zoom / Powered Focus
	Lens Shift	Powered, Vertical +/- 80% Horizontal +/- 31%
	Throw Ratio	1.27:1 to 2.73:1
Screen Size		60" to 300"
Interface		
Input/Output	HDMI (2 inputs)	Digital RGB/Y Pb/Cb Pr/Cr
	Y Pb/Cb Pr/Cr	Component: phono type
	INPUT A	Mini D-sub 15-pin (RGB)
	Trigger (2 connectors)	Mini Jack, DC 12V Max. 100mA
	Remote	RS232C, D-sub 9-pin (female)
	LAN	RJ45, 10BASE-T/100BASE-TX
	IR IN	Mini Jack
	3D Sync	RJ45/Built-in transmitter
General		
Scanning Frequency		H: 19 to 72 kHz, V: 48 to 92 Hz
Display Resolution	Computer Signal Input	Maximum display resolution : 1920x1080 dots
	Video Signal Input	480/60i, 576/50i, 480/60p, 576/50p, 720/60p, 720/50p, 1080/60i, 1080/50i The following items are available for HDMI input only. 1080/60p, 1080/50p, 1080/24p, 3840 x 2160/24p, 3840 x 2160/25p, 3840 x 2160/30p, 4096 x 2160/24p
Power Requirements		AC 100 V to 240 V, 4.8 A to 2.0 A, 50 Hz/60 Hz
Power Consumption		480 W (AC 100 V) 470 W (AC 120 V) 460 W (AC 220 V-240 V)
Standby Mode Power Consumption		3.5 W (Std) / 0.3 W (Low) (AC 100V) 3.5 W (Std) / 0.3 W (Low) (AC 120 V) 3.9 W (Std) / 0.4 W (Low) (AC 220V-240 V)

Specifications		VPL-VW1000ES
General		
Dimensions (WxHxD) (without protrusion)		520x200x640 mm 20 1/2 x 7 7/8 x 25 1/4 "
Mass		20.0 kg/44 lb 1.5 oz
Service Parts		
Replacement Remote		1-490-070-11 (RM-PJ22)

- *1 The value is average.
*2 The figures are expected maintenance time and not guaranteed.
They will depend on the environment or how the projector is used.
*3 2x 3D glasses bundled with VPL-VW1000ES.

Optional Accessories

TDG-PJI*3
3D Glasses



TMR-PJI
3D Transmitter



LMP-H330
Projector Lamp (for replacement)



© 2012 Sony Corporation. All rights reserved. Reproduction in whole or in part without permission is prohibited. Features and specifications are subject to change without notice. All non-metric weights and measurements are approximate. Sony and make.believe are trademarks of Sony Corporation. All other trademarks are the property of their respective owners.

Distributed by

About Sony Professional

Sony Professional is the leading supplier of AV/IT solutions to businesses across a wide variety of sectors including, **Media and Broadcast, Video Security and Retail, Transport & Large Venue markets.** It delivers products, systems and applications to enable the creation, manipulation and distribution of digital audio-visual content that add value to businesses and their customers. With over 25 years' experience in delivering innovative market-leading products, **Sony Professional** is ideally placed to deliver exceptional quality and value to its customers. **Sony's Professional Services** division, its systems integration arm, offers its customers access to the expertise and local knowledge of skilled professionals across Europe. Collaborating with a network of established technology partners, Sony Professional delivers end-to-end solutions that address the customer's needs, integrating software and systems to achieve each organisation's individual business goals. For more information please visit www.pro.sony.eu

HCT_VPLVW1000ES_11181_UK_07/02/2012

SONY
make.believe